



US 20190198791A1

(19) **United States**

(12) **Patent Application Publication**
KIM et al.

(10) **Pub. No.: US 2019/0198791 A1**

(43) **Pub. Date: Jun. 27, 2019**

(54) **ORGANIC LIGHT EMITTING DIODE AND ORGANIC LIGHT EMITTING DISPLAY INCLUDING THE SAME**

(71) Applicant: **LG Display Co., Ltd.**, Seoul (KR)

(72) Inventors: **Sangbeom KIM**, Paju-si (KR); **Jeongdae SEO**, Incheon (KR); **Dohan KIM**, Goyang-si (KR); **Hyeseung KANG**, Seoul (KR); **Seonkeun YOO**, Gunpo-si (KR); **Seunghee YOON**, Seoul (KR); **Daewon RYU**, Gimpo-si (KR); **Jicheol SHIN**, Seoul (KR)

(73) Assignee: **LG Display Co., Ltd.**, Seoul (KR)

(21) Appl. No.: **16/217,164**

(22) Filed: **Dec. 12, 2018**

(30) **Foreign Application Priority Data**

Dec. 22, 2017 (KR) 10-2017-0178313

Publication Classification

(51) **Int. Cl.**
H01L 51/50 (2006.01)
H01L 51/52 (2006.01)
H01L 27/32 (2006.01)
(52) **U.S. Cl.**
CPC *H01L 51/506* (2013.01); *H01L 51/5004* (2013.01); *H01L 27/3209* (2013.01); *H01L 51/5262* (2013.01); *H01L 51/5203* (2013.01)

(57) **ABSTRACT**

Disclosed is an organic light emitting diode and an organic light emitting display including the same, where the organic light emitting diode includes: a first electrode; a light emitting stack disposed on the first electrode; and a second electrode disposed on the light emitting stack, where the light emitting stack includes a hole transport layer and a blue light emitting layer such that the hole transport layer and the blue light emitting layer are sequentially stacked on the first electrode, where the blue light emitting layer includes a blue host material and a blue fluorescent dopant material, and the hole transport layer includes a hole transport layer material. The blue fluorescent dopant material has a higher LUMO energy level than the blue host material and the blue fluorescent dopant material has a higher HOMO energy level than the blue host material.

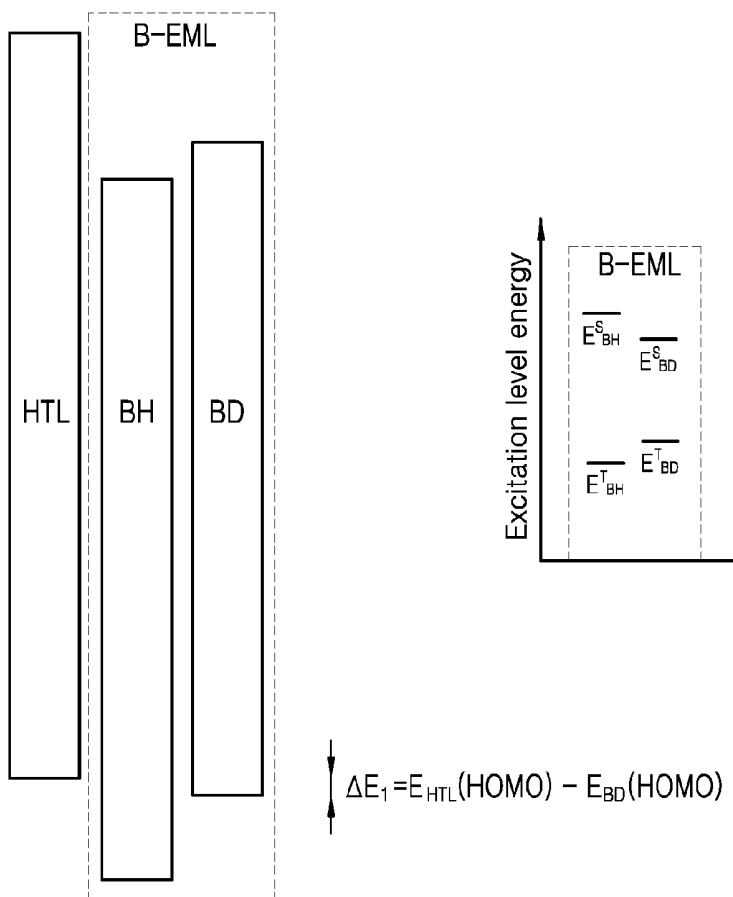

FIG. 1

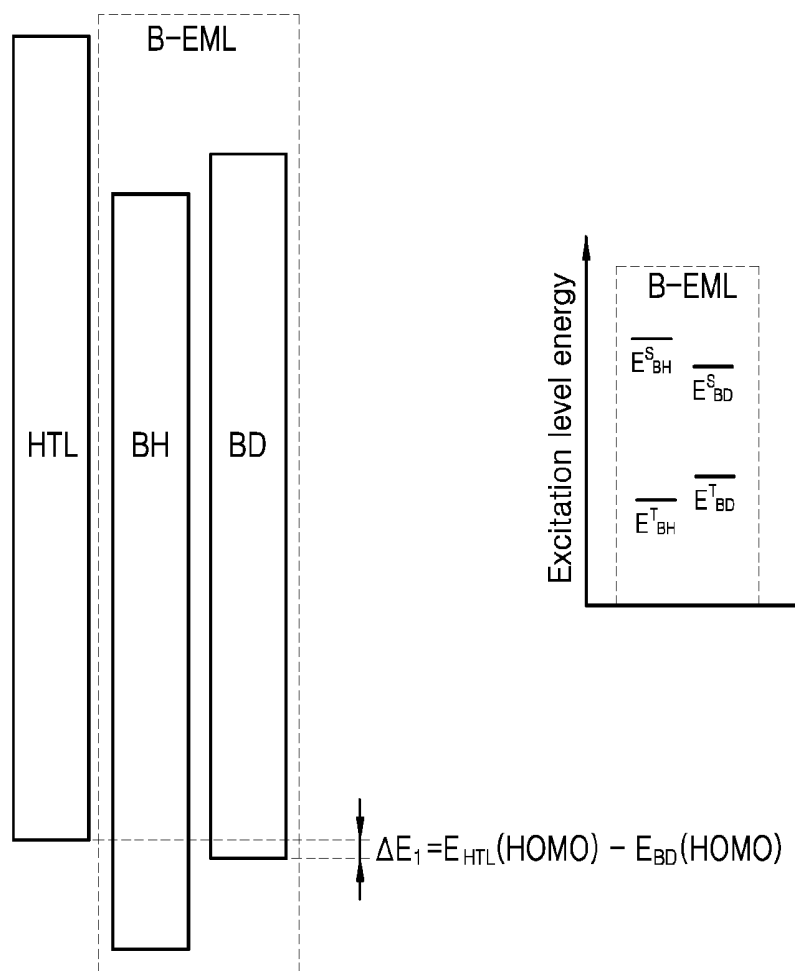

FIG. 2

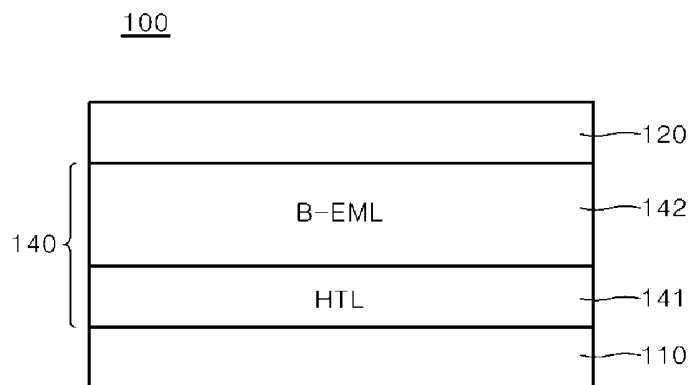

FIG. 3

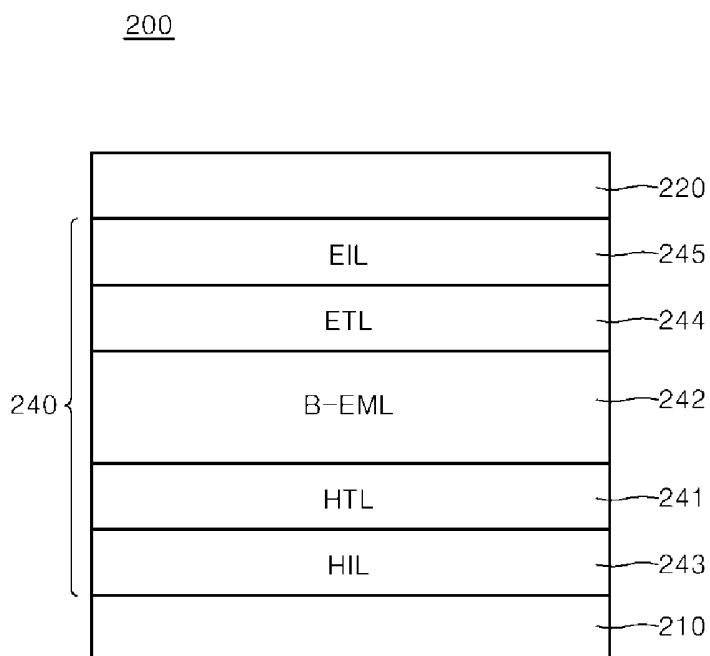

FIG. 4

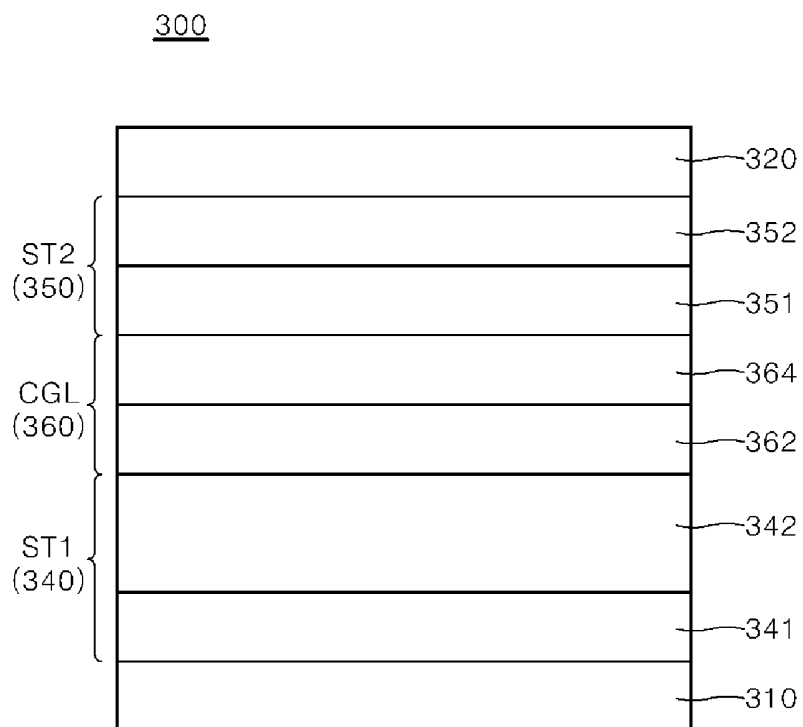

FIG. 5

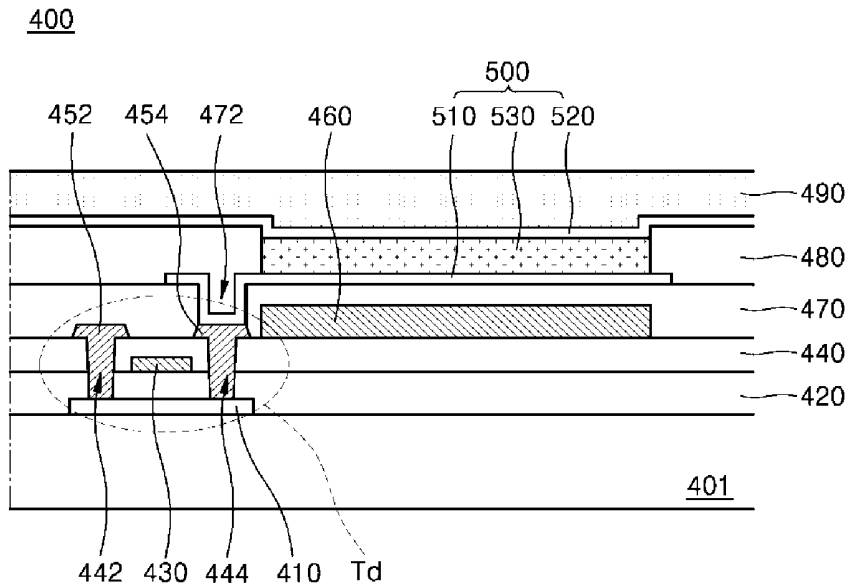

FIG. 6

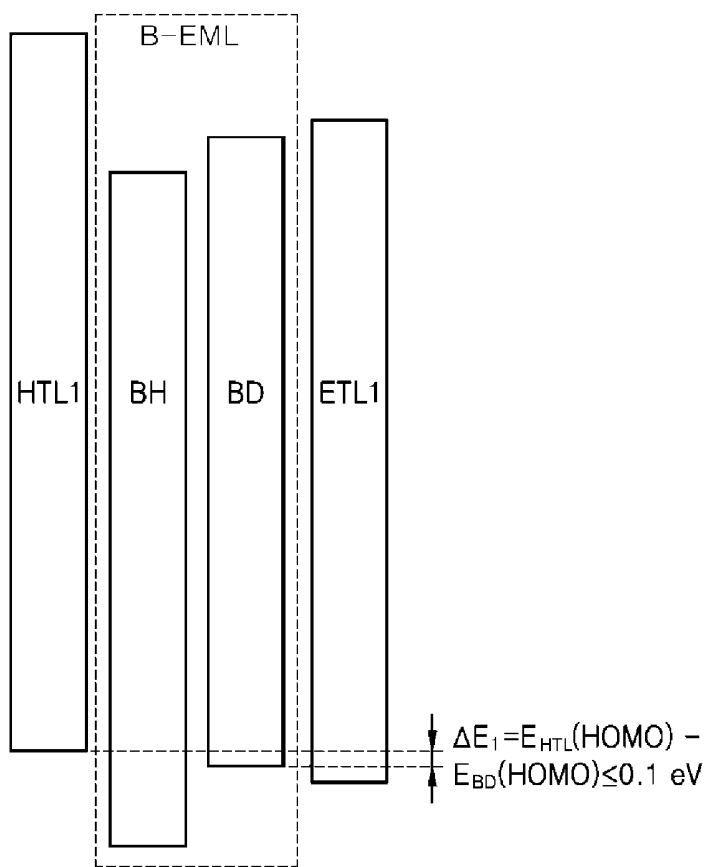
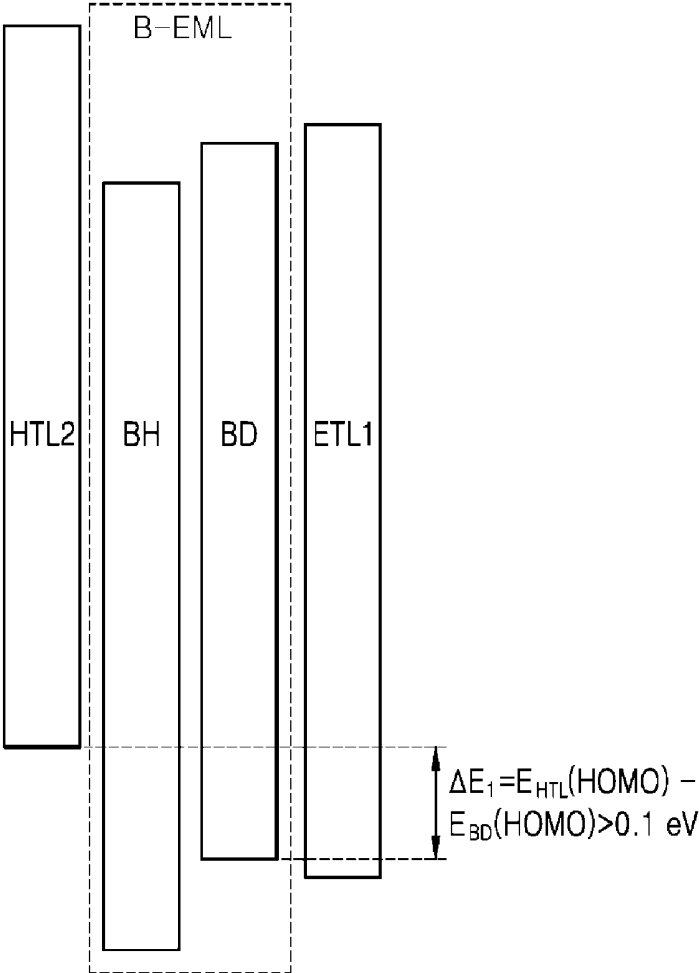

FIG. 7



**ORGANIC LIGHT EMITTING DIODE AND
ORGANIC LIGHT EMITTING DISPLAY
INCLUDING THE SAME**

CROSS-REFERENCE TO RELATED
APPLICATIONS

[0001] This application claims the benefit of Korean patent application No. 10-2017-0178313 filed on Dec. 22, 2017, the entire content of which is incorporated herein by reference in its entirety.

BACKGROUND

1. Technical Field

[0002] The present invention relates to an organic light emitting diode and an organic light emitting display including the same.

2. Description of the Related Art

[0003] Recently, there has been an increased interest in flat display elements occupying a small space, with an increasing size of displays. The technology of organic light emitting displays including organic light emitting diodes (OLEDs) as the flat display elements has been rapidly developing in the art.

[0004] An organic light emitting diode emits light through conversion of the energy of excitons created by pairs of electrons and holes generated upon injection of charges into an organic light emitting layer formed between an anode and a cathode. As compared with exiting display techniques, the organic light emitting diode has various advantages, such as low voltage operation, low power consumption, good color reproduction, and various applications through application of a flexible substrate.

[0005] Generally, OLEDs can be classified into single OLEDs and tandem OLEDs. The tandem OLED refers to an OLED including two or more light emitting stacks and allows for a more easily achieved improvement in operation voltage and efficiency compared to an existing single OLED.

[0006] In a typical white organic light emitting diode (WOLED), the difference in energy levels between the functional layers constituting a blue light emitting layer results in decreased efficiency during injection of electrons or holes at an interface between the functional layers, thereby having a negative influence on the performance and lifespan of the WOLED.

SUMMARY OF THE INVENTION

[0007] It is one aspect of the present invention to provide an organic light emitting diode capable of reducing the operation voltage while improving the luminous efficacy and lifespan thereof, and an organic light emitting display including the same.

[0008] In accordance with one aspect of the present invention, there is provided an organic light emitting diode including: a first electrode; a light emitting stack disposed on the first electrode; and a second electrode disposed on the light emitting stack.

[0009] The light emitting stack may include a hole transport layer and a blue light emitting layer such that the hole transport layer and the blue light emitting layer are sequentially stacked on the first electrode, in which the blue light emitting layer includes a blue host material and a blue

fluorescent dopant material, and the hole transport layer includes a hole transport layer material.

[0010] The blue fluorescent dopant material has a higher LUMO (Lowest Unoccupied Molecular Orbital) energy level than the blue host material.

[0011] The blue fluorescent dopant material has a higher HOMO (Highest Occupied Molecular Orbital) energy level than the blue host material.

[0012] The hole transport layer material has a higher HOMO energy level than the blue host material.

[0013] The hole transport layer material has a higher HOMO energy level than the blue fluorescent dopant material and the difference in HOMO energy levels between the hole transport layer material and the blue fluorescent dopant material is 0.1 eV or less.

[0014] The blue fluorescent dopant material has a lower singlet energy than the blue host material.

[0015] The present invention provides an organic light emitting diode that includes a blue light emitting layer while achieving improved operating characteristics and a long lifespan.

BRIEF DESCRIPTION OF THE DRAWINGS

[0016] The accompanying drawings, which are included to provide a further understanding of the disclosure, illustrate embodiments of the disclosure and together with the description serve to explain various principles.

[0017] FIG. 1 is an energy diagram depicting energy levels of a hole transport layer (HTL) and a blue light emitting layer (B-EML) of an organic light emitting diode according to the present invention.

[0018] FIG. 2 is a sectional view of an organic light emitting diode according to one exemplary embodiment of the present invention.

[0019] FIG. 3 is a sectional view of an organic light emitting diode according to another exemplary embodiment of the present invention.

[0020] FIG. 4 is a sectional view of an organic light emitting diode according to a further exemplary embodiment of the present invention.

[0021] FIG. 5 is a sectional view of an organic light emitting display according to one exemplary embodiment of the present invention.

[0022] FIG. 6 is an energy diagram depicting energy levels of an organic light emitting diode of Example 1.

[0023] FIG. 7 is an energy diagram depicting energy levels of an organic light emitting diode of Comparative Example 1.

DETAILED DESCRIPTION

[0024] Hereinafter, embodiments of the present invention will be described in detail with reference to the accompanying drawings such that the technical idea of the present invention can be more easily realized by those skilled in the art. It should be understood that the present invention is not limited to the following embodiments and may exist as different embodiments.

[0025] In the drawings, the portions irrelevant to the description will be omitted for clarity and like components will be denoted by like reference numerals throughout the specification. In addition, description of known functions and constructions which may unnecessarily obscure the subject matter of the present invention will be omitted.

[0026] It will be understood that, when an element such as a layer, film, region or substrate is referred to as being placed “above”/“below” or “on”/“under” another element, it can be directly placed on the other element, or intervening layer(s) may also be present. It will be understood that, although the terms “first”, “second”, “A”, “B”, etc. may be used herein to describe various elements, components, regions, layers and/or sections, these elements, components, regions, layers and/or sections should not be limited by these terms. These terms are only used to distinguish one element, component, region, layer or section from another element, component, region, layer or section. Thus, a “first” element or component discussed below could also be described as a “second” element or component, or vice versa, without departing from the scope of the present invention. When an element or layer is referred to as being “on,” “connected to,” or “coupled to” another element or layer, it may be directly on, connected to, or coupled to the other element or layer or intervening elements or layers may be present. However, when an element or layer is referred to as being “directly on,” “directly connected to,” or “directly coupled to” another element or layer, there are no intervening elements or layers present.

[0027] In accordance with one aspect of the present invention, there is provided an organic light emitting diode including: a first electrode; a light emitting stack disposed on the first electrode; and a second electrode disposed on the light emitting stack.

[0028] The light emitting stack includes a hole transport layer and a blue light emitting layer such that the hole transport layer and the blue light emitting layer are sequentially stacked on the first electrode.

[0029] The blue light emitting layer includes a blue host material and a blue fluorescent dopant material.

[0030] The hole transport layer includes a hole transport layer material.

[0031] The light emitting stack satisfies the following energy level conditions (A) to (E):

[0032] (A) The blue fluorescent dopant material has a higher LUMO (Lowest Unoccupied Molecular Orbital) energy level than the blue host material;

[0033] (B) the blue fluorescent dopant material has a higher HOMO (Highest Occupied Molecular Orbital) energy level than the blue host material;

[0034] (C) the hole transport layer material has a higher HOMO energy level than the blue host material;

[0035] (D) the hole transport layer material has a higher HOMO energy level than the blue fluorescent dopant material and the difference in HOMO energy levels between the hole transport layer material and the blue fluorescent dopant material is 0.1 eV or less; and

[0036] (E) the blue fluorescent dopant material has a lower singlet energy level than the blue host material.

[0037] The organic light emitting diode including the light emitting stack that satisfies the energy level conditions of the blue fluorescent dopant material and the blue host material facilitates injection and recombination of electrons and holes in the blue light emitting layer such that excitons can be generated only within the light emitting layer, thereby improving the operating characteristics and the lifespan thereof.

[0038] Further, in the organic light emitting diode including the hole transport layer satisfying the energy level conditions of the hole transport layer material, holes are

injected into the light emitting layer through the hole transport layer at the anode and the blue fluorescent dopant material forming the light emitting layer exhibits strong hole characteristics. In this case, a small difference in the HOMO energy levels may be set between the blue fluorescent dopant material exhibiting the hole characteristics and the hole transport layer, thereby improving hole injection from the hole transport layer into the light emitting layer. With this structure, the organic light emitting diode can achieve improved operating characteristics and a long lifespan.

[0039] FIG. 1 is an energy diagram depicting energy levels of a hole transport layer (HTL) and a blue light emitting layer (B-EML) of an organic light emitting diode according to the present invention. In FIG. 1, the blue light emitting layer (B-EML) is composed of a blue fluorescent dopant material (BD) and a blue host material (BH).

[0040] Referring to FIG. 1, the energy level of each layer in the organic light emitting diode satisfies Conditions (A) to (E). Specifically, as shown in FIG. 1, the blue fluorescent dopant material (BD) has a higher LUMO energy level than the blue host material (BH), satisfying Condition (A). In addition, the blue fluorescent dopant material (BD) has a higher HOMO energy level than the blue host material (BH), satisfying Condition (B). Also, the hole transport layer (HTL) material has a higher HOMO energy level than the blue host material (BH), satisfying Condition (C). In addition, the ΔE_1 reflects Condition (D) wherein the hole transport layer (HTL) material has a higher HOMO energy level than the blue fluorescent dopant material (BD). Specifically, the difference in the HOMO energy levels between the hole transport layer material and the blue fluorescent dopant material is 0.1 eV or less. Thus, $\Delta E_1 \leq 0.1$ eV. In the excitation energy graph at the right side of FIG. 1, the blue fluorescent dopant material (BD) has a lower singlet energy than the blue host material, satisfying Condition (E).

[0041] FIG. 2 is a sectional view of an organic light emitting diode 100 according to one exemplary embodiment of the present invention, which includes a first electrode 110, a light emitting stack 140 including a hole transport layer (HTL) 141 and a blue light emitting layer (B-EML) 142 adjoining the hole transport layer (HTL) 141, and a second electrode 120.

[0042] The first electrode 110 is an anode through which holes are injected into the organic light emitting diode, and may be formed of a conductive material having a high work function. For example, the first electrode 110 may be formed of at least one of indium tin oxide (ITO), indium zinc oxide (IZO), and zinc oxide (ZnO).

[0043] The second electrode 120 is a cathode through which electrons are injected into the organic light emitting diode, and may be formed of a conductive material having a low work function. For example, the second electrode 120 may be formed of at least one of aluminum (Al), magnesium (Mg), and aluminum-magnesium alloys (AlMg).

[0044] The light emitting stack 140 includes the hole transport layer (HTL) 141 and the blue light emitting layer (BML) 142 interposed between the first electrode 110 and the second electrode 120.

[0045] The hole transport layer (HTL) 141 is interposed between the first electrode 110 and the blue light emitting layer (B-EML) 142.

[0046] The hole transport layer (HTL) 141 may be formed of any one selected from the group consisting of N,N'-diphenyl-N,N'-bis(3-methylphenyl)-1,1'-biphenyl-4,4'-di-

amine (TPD), NPD, MTDATA, 1,3-bis(N-carbazolyl)benzene (mCP), CuPC, TCTA, tris(trifluorovinylether)-tris(4-carbazolyl-9-yl-phenyl)amine (TFV-TCTA), tris[4-(diethylamino)phenyl]amine, N-(biphenyl-4-yl)-9,9-dimethyl-N-(4-(9-phenyl-9H-carbazol-3-yl)phenyl)-9H-fluorene-2-amine, tri-p-tolylamine, N-[1,1'-biphenyl]-4-yl-9,9-dimethyl-N-[4-(9-phenyl-9H-carbazol-3-yl)phenyl]-amine, 4,4'-bis(N-carbazolyl)-1,1'-biphenyl (CBP), 1,1-bis(4-(N,N'-di(p-tolyl)amino)phenyl)cyclohexane (TAPC), and combinations thereof.

[0047] The blue light emitting layer (B-EML) **142** includes a blue host material (BH) and a blue fluorescent dopant material (BD).

[0048] In one embodiment, the blue host material (BH) may include an anthracene-containing compound. Specifically, the blue host material (BH) may include one compound selected from the group consisting of 9,10-di(2-naphthyl)anthracene (ADN), 2-tert-butyl-9,10-di(2-naphthyl)anthracene, 2-methyl-9,10-di(2-naphthyl)anthracene (MADN), and combinations thereof.

[0049] In another embodiment, the blue fluorescent dopant material (BD) may include a pyrene amine-containing compound. Specifically, the blue fluorescent dopant material (BD) may include a compound selected from the group consisting of 1,6-bis(diphenylamine)pyrene, tetrakis(t-butyl)perylene (TBPe), and combinations thereof, without being limited thereto.

[0050] The blue light emitting layer (B-EML) **142** may include 1% by weight (wt %) to 5 wt % of the blue fluorescent dopant material (BD). Within this content of the blue fluorescent dopant material (BD), the blue light emitting layer (B-EML) **142** can effectively satisfy the energy level conditions described above. If the content of the blue fluorescent dopant material (BD) exceeds this range, concentration extinction can occur between dopant materials, thereby causing decreased efficiency at high brightness. If the content of the blue fluorescent dopant material (BD) is less than this range, energy transfer from a host to a dopant becomes difficult, thereby making it difficult to obtain a desired level of luminosity while reducing the lifespan of the organic light emitting diode due to side reactions in the light emitting layer.

[0051] The light emitting stack **140** may optionally further include a hole injection layer (HIL), an electron transport layer (ETL), and an electron injection layer (EIL), as needed.

[0052] The hole injection layer (HIL) may be interposed between the first electrode **120** and the hole transport layer (HTL) **142**. The hole injection layer (HIL) improves the interface characteristics between the first electrode **120** formed of an inorganic material and the hole transport layer (HTL) **142** formed of an inorganic material.

[0053] For example, the hole injection layer (HIL) may include one material selected from the group consisting of 4,4',4''-tris(3-methylphenylphenylamino)triphenylamine (MTDATA), copper phthalocyanine (CuPc), tris(4-carbazolyl-9-yl-phenyl)amine (TCTA), N,N'-diphenyl-N,N'-bis(1-naphthyl)-1,1'-biphenyl-4,4''-diamine (NPB, NPD), 1,4,5,8,9,11-hexaazatriphenylenehexacarbonitrile (HATCN), 1,3,5-tris[4-(diphenylamino)phenyl]benzene (TDAPB), poly(3,4-ethylenedioxythiophene)polystyrene sulfonate (PEDOT/PSS), 2,3,5,6-tetrafluoro-7,7,8,8-tetracyanoquinodi-

methane (F4-TCNQ), N-(biphenyl-4-yl)-9,9-dimethyl-N-(4-(9-phenyl-9H-carbazol-3-yl)phenyl)-9H-fluorene-2-amine, and combinations thereof.

[0054] The electron transport layer (HTL) may be interposed between the blue light emitting layer (B-EML) **142** and the second electrode **120** and serves to secure the efficient transport of electrons.

[0055] For example, the electron transport layer (HTL) may include derivatives, such as oxadiazole, triazole, phenanthroline, benzoxazole, benzothiazole, benzimidazole, triazine, and the like.

[0056] Specifically, the electron transport layer (HTL) may be formed of an electron transport material selected from the group consisting of Alq₃, 2-biphenyl-4-yl-5-(4-tert-butylphenyl)-1,3,4-oxadiazole (PBD), spiro-PBD, lithium quinolate (Liq), 2-[4-(9,10-Di-2-naphthalenyl-2-anthracenyl)phenyl]-1-phenyl-1H-benzimidazol, 3-(biphenyl-4-yl)-5-(4-tertbutylphenyl)-4-phenyl-4H-1,2,4-triazole (TAZ), 4,7-diphenyl-1,10-phenanthroline (Bphen), tris(phenylquinoxaline) (TPQ), 1,3,5-tri[(3-pyridyl)-phen-3-yl]benzene (TmPyPB), 1,3,5-tris(N-phenylbenzimidazole-2-yl)benzene (TPBI), and combinations thereof.

[0057] Optionally, the electron transport layer (HTL) may be formed by doping with an alkali metal or alkaline earth metal compound. Examples of metal components that can be used as a dopant for the electron transport layer (HTL) may include alkali metals, such as lithium (Li), sodium (Na), potassium (K) and cesium (Cs), and alkaline earth metals, such as magnesium (Mg), strontium (Sr), barium (Ba), and radium (Ra), without being limited thereto. The alkali metal or alkaline earth metal compound may be present in an amount of about 1 wt % to 20 wt %, without being limited thereto.

[0058] The electron injection layer (EIL) may be interposed between the electron transport layer (ETL) and the second electrode **120** and serves to secure efficient injection of electrons. For example, the electron injection layer (EIL) may include at least one selected from the group consisting of alkali and alkaline earth halides, such as LiF, NaF, KF, RbF, CsF, FrF, BeF₂, MgF₂, CaF₂, SrF₂, BaF₂ and RaF₂; and organic materials, such as Liq (lithium quinolate), lithium benzoate, sodium stearate, Alq₃, BA1q, PBD, spiro-PBD, and TAZ, and combinations thereof.

[0059] FIG. 3 is a sectional view of an organic light emitting diode **200** according to another exemplary embodiment of the present invention, which includes a first electrode **210**, a light emitting stack **240** and a second electrode **220**. Referring to FIG. 3, the light emitting stack **240** includes a hole injection layer (HIL) **243**, a hole transport layer (HTL) **241**, a blue light emitting layer (B-EML) **242**, an electron transport layer (ETL) **244**, and an electron injection layer (EIL) **245**. Details of the layers stacked in the organic light emitting diode **200** according to this embodiment are the same as those described for the above embodiment and so a detailed description thereof will be omitted.

[0060] The organic light emitting diode may have a tandem structure including at least two light emitting stacks.

[0061] In one embodiment, in each of the light emitting stacks **142**, **242** is a first light emitting stack, and the organic light emitting diode may further include at least one additional light emitting stack including a second light emitting stack interposed between the first electrode and the second electrode.

[0062] FIG. 4 is a sectional view of an organic light emitting diode 300 according to a further exemplary embodiment of the present invention, which includes a first electrode 310, a first light emitting stack (ST1) 340, a charge generation layer (CGL) 360, a second light emitting stack (ST2) 350, and a second electrode 320. Referring to FIG. 4, the first light emitting stack (ST1) 340 includes a first hole transport layer (HTL) 341 and a first blue light emitting layer 342, and the second light emitting stack (ST2) 350 includes a second hole transport layer (HTL) 351 and a second blue light emitting layer 352. In addition, each of the first light emitting stack (ST1) 340 and the second light emitting stack (ST2) 350 may further include an organic layer, such as a hole injection layer, a hole transport layer, an electron transport layer, and an electron injection layer, as needed. Details of the layers stacked in the organic light emitting diode 300 according to this embodiment are the same as those described for the above embodiment and so a detailed description thereof will be omitted.

[0063] In the organic light emitting diode 300, the charge generation layer (CGL) 360 is interposed between the first light emitting stack (ST1) 340 and the second light emitting stack (ST2) 350 to improve current efficiency in each of the light emitting layers while securing efficient distribution of charges. That is, the charge generation layer 360 is interposed between first light emitting stack (ST1) 340 and the second light emitting stack (ST2) 350. The first light emitting stack (ST1) 340 is connected to the second light emitting stack (ST2) 350 by the charge generation layer 360. The charge generation layer 360 may be a PN junction charge generation layer in which an N-type charge generation layer 362 adjoins a P-type charge generation layer 364.

[0064] The N-type charge generation layer 362 is disposed to face the first light emitting stack (ST1) 340 and the P-type charge generation layer 364 is disposed to face the second light emitting stack (ST2) 350. The charge generation layer 360 generates charges or divides the charges into holes and electrons to supply the holes and electrons to the first and second light emitting stacks 340, 350.

[0065] That is, the N-type charge generation layer 362 supplies electrons to the first light emitting stack (ST1) 340 adjacent to the first electrode 310. The P-type charge generation layer 364 supplies holes to the second light emitting stack (ST2) 350 and the second hole transport layer 351 supplies holes to the second light emitting stack (ST2) 350 adjacent to the second electrode 320.

[0066] The N-type charge generation layer 362 may be formed to constitute a host-dopant system and thus include an N-type dopant material and an N-type host material. The N-type dopant material may include Group I and II metals from the periodic table, organic materials capable of supplying electrons, or a mixture thereof. For example, the N-type dopant material may include one of an alkali metal and an alkaline earth metal. That is, the N-type charge generation layer 362 may be an organic layer formed by doping with an alkali metal, such as lithium (Li), sodium (Na), potassium (K), and cesium (Cs), or an alkaline earth metal, such as magnesium (Mg), strontium (Sr), barium (Ba), and radium (Ra), without being limited thereto. The N-type host material may include at least one material capable of supplying electrons and selected from the group consisting of, for example, tris(8-hydroxyquinolino)aluminum (Alq₃), 8-hydroxyquinolinolato-lithium (Liq), 2-(4-biphenyl)-5-(4-tert-butylphenyl)-1,3,4-oxadiazole (PBD),

3-(4-biphenyl)4-phenyl-5-tert-butylphenyl-1,2,4-triazole (TAZ), Spiro-PBD, bis(2-methyl-8-quinolinolato)-4-(phenylphenolato)aluminum (BALq), SALq, 2,2',2'-(1,3,5-benzinetriyl)-tris(1-phenyl-1-H-benzimidazole (TPBi), oxadiazole, triazole, phenanthroline, benzoxazole, and benzthiazole, without being limited thereto.

[0067] Alternatively, the N-type charge generation layer 362 may not constitute the host-dopant system. That is, the N-type charge generation layer 362 may be free from the N-type dopant material.

[0068] The P-type charge generation layer 364 may include a P-type dopant material and a P-type host material. The P-type charge generation layer 364 is disposed on the N-type charge generation layer 362 to form a PN junction together with the N-type charge generation layer 362. The P-type dopant material may include a metal oxide, an organic material, such as tetrafluoro-tetracyanoquinodimethane (F4-TCNQ), hexaazatriphenylenehexacarbonitrile (HAT-CN), hexaazatriphenylene, and the like, or a metallic material, such as V₂O₅, MoO_x, and WO₃, without being limited thereto. The P-type host material may include at least one material capable of transferring holes selected from the group consisting of, for example, N,N-dinaphthyl-N,N'-diphenyl benzidine (N,N-bis(naphthalene-1-yl)-N,N-bis(phenyl)-2,2'-dimethyl benzidine, NPD), N,N'-bis-(3-methylphenyl)-N,N'-bis-(phenyl)-benzidine (TPD), and 4,4',4'-tris(N-3-methylphenyl-N-phenyl-amino)-triphenylamine (MTDATA), without being limited thereto.

[0069] The additional light emitting stack may emit red (R), green (G) or yellow (Y) light.

[0070] In one embodiment, the first light emitting stack (ST1) 340 may emit blue light and the second light emitting stack (ST2) 350 may emit green (G), yellow green (YG), yellow (Y) or orange light, which has a longer wavelength than the blue light.

[0071] In one embodiment, the organic light emitting diode may be a white organic light emitting diode which has luminous characteristics of red (R), green (G), and blue (B) colors, which are the three primary colors of light. For example, in the white organic light emitting diode, the first light emitting stack (ST1) 340 emits blue light and the second light emitting stack (ST2) 350 includes one host material and a yellow dopant to emit yellow (Y) light such that the white organic light emitting diode emits blue and yellow light, thereby realizing white light. In operation of the white organic light emitting diode, white light can be realized through the mixture of light emitted from the first light emitting stack (ST1) 340 and light emitted from the second light emitting stack (ST2) 350.

[0072] The organic light emitting diode may be applied to an organic light emitting display and a lighting apparatus.

[0073] In accordance with another aspect of the present invention, there is provided an organic light emitting display, which includes a substrate, an organic light emitting diode disposed above the substrate, and a driving device interposed between the substrate and the organic light emitting diode and connected to the first electrode.

[0074] FIG. 5 is a sectional view of an organic light emitting display according to one exemplary embodiment of the present invention.

[0075] Referring to FIG. 5, an organic light emitting display 400 according to one exemplary embodiment may include a substrate 401, an organic light emitting diode 500, and an encapsulation layer 490 covering the organic light

emitting diode **500**. The encapsulation layer **490** may have a multilayer structure of an inorganic material layer/organic material layer/inorganic material layer. A thin film transistor Td acting as a driving device and the organic light emitting diode **500** connected to the thin film transistor Td are disposed on the substrate **401**.

[0076] Although not shown in the drawings, the organic light emitting display further includes a gate line and a data line intersecting each other to define a pixel region, a power line extending parallel to one of the gate line and the data line and separated therefrom, a switching thin film transistor connected to the gate line and the data line, and a storage capacitor connected to the power line and one electrode of the switching thin film transistor on the substrate **401**.

[0077] The thin film transistor Td is connected to the switching thin film transistor and includes a semiconductor layer **410**, a gate electrode **430**, a source electrode **452** and a drain electrode **454**.

[0078] The semiconductor layer **410** is formed on the substrate **401** and may be formed of an oxide semiconductor material or polycrystalline silicon. When the semiconductor layer **410** is formed of the oxide semiconductor material, a light shielding pattern (not shown) may be formed under the semiconductor layer **410** to prevent degradation of the semiconductor layer **401** due to light by blocking light from entering the semiconductor layer **410**. Alternatively, the semiconductor layer **410** may be formed of polycrystalline silicon. In this alternative embodiment, both edges of the semiconductor layer **410** may be doped with impurities.

[0079] A gate insulation layer **420** comprising an insulating material may be formed over the substrate **401** to be disposed on the semiconductor layer **410**. The gate insulation layer **420** may be formed of an inorganic insulating material, such as silicon oxide or silicon nitride.

[0080] The gate electrode **430** is formed of a conductive material such as a metal and is disposed at a location on the gate insulation layer **420** corresponding to the center of the semiconductor layer **410**. The gate electrode **430** is connected to the switching thin film transistor.

[0081] An interlayer insulation layer **440** is formed of an insulating material over the substrate **401** to be disposed on the gate electrode **430**. The interlayer insulation layer **440** may be formed of an inorganic insulation material, such as silicon oxide or silicon nitride, or an organic insulation material, such as benzocyclobutene or photo-acryl.

[0082] The interlayer insulation layer **440** has first and second semiconductor layer contact holes **442** and **444**, respectively, which expose opposite sides of the semiconductor layer **410**, respectively. The first and second semiconductor layer contact holes **442** and **444** are disposed at opposite sides of the gate electrode **430** to be separated therefrom.

[0083] A source electrode **452** and a drain electrode **454** formed of a conductive material are disposed on the interlayer insulation layer **440**. The source electrode **452** and the drain electrode **454** are separated from each other around the gate electrode **430** and contact the opposite sides of the semiconductor layer **410** through the first and second semiconductor layer contact holes **442** and **444**, respectively. The source electrode **452** is connected to the power line (not shown).

[0084] The semiconductor layer **410**, the gate electrode **430**, the source electrode **452**, and the drain electrode **454** constitute the thin film transistor Td. In this embodiment, the

thin film transistor Td has a coplanar structure wherein the gate electrode **430**, the source electrode **452** and the drain electrode **454** are disposed on the semiconductor layer **410**.

[0085] Alternatively, the thin film transistor Td may have an inverted staggered structure wherein the gate electrode is disposed at a lower side of a semiconductor layer and the source electrode and the drain electrode are disposed at an upper side of the semiconductor layer. In this structure, the semiconductor layer may be formed of non-crystalline silicon. On the other hand, the switching thin film transistor (not shown) may have substantially the same structure as the thin film transistor Td.

[0086] The organic light emitting display **400** may include a color filter **460** that absorbs light emitted from the organic light emitting diode **500**. For example, the color filter **360** can absorb red (R), green (G), blue (B) and white (W) light. In this case, each of color filter patterns adapted to absorb red, green and blue light may be separately formed in the corresponding pixel region to overlap an organic light emitting layer **530** of the organic light emitting diode **500**, which emits light in a wavelength band to be absorbed by the corresponding color filter pattern. With the color filter **460**, the organic light emitting display **400** can realize full-color display.

[0087] For example, when the organic light emitting display **400** is a bottom emission type, the color filter **460** for absorbing light may be disposed on the interlayer insulation layer **440** that corresponds to the organic light emitting diode **500**. In an alternative embodiment, in which the organic light emitting display **400** is a top emission type, the color filter may be disposed on the organic light emitting diode **500**, that is, on the second electrode **520**. By way of example, the color filter **460** may have a thickness of 2 μm to 5 μm . In this embodiment, the organic light emitting diode **500** may be a white light emitting diode having a tandem structure, as shown in FIG. 4.

[0088] A protective layer **470** is formed to cover the thin film transistor Td. The protective layer **470** has a drain contact hole **472** that exposes the drain electrode **454**.

[0089] A first electrode **510** is formed on the protective layer **470** to be separately disposed in each pixel region and is connected to the drain electrode **454** of the thin film transistor Td through the drain contact hole **472**.

[0090] The first electrode **510** may be an anode and may be formed of a conductive material having a relatively high work function. For example, the first electrode **510** may be formed of a transparent conductive material, such as ITO, IZO or ZnO.

[0091] On the other hand, when the organic light emitting display **400** is a top emission type, a reflective electrode or a reflective layer may be further formed on a lower surface of the first electrode **510**. For example, the reflective electrode or the reflective layer may be formed of one material selected from among aluminum (Al), silver (Ag), nickel (Ni), and aluminum-palladium-copper (APC) alloys.

[0092] A bank layer **486** may be formed on the protective layer **470** to cover an edge of the first electrode **510**. The bank layer **486** exposes a central region of the first electrode **510** corresponding to the pixel region.

[0093] A light emitting stack **530** is formed on the first electrode **510**. By way of example, the light emitting stack **530** may include at least two light emitting stacks as shown in FIG. 4 to form a tandem structure of the organic light emitting diode **500**.

[0094] A second electrode 520 is formed on the light emitting stack 530 to be disposed above the substrate 401. The second electrode 520 is disposed over a display region and may be formed of a conductive material having a relatively low work function to be used as a cathode. For example, the second electrode 520 may be formed of one of aluminum (Al), magnesium (Mg), and an AlMg alloy.

[0095] The first electrode 510, the light emitting stack 530 and the second electrode 520 constitute the organic light emitting diode 500.

[0096] An encapsulation layer 490 is formed on the second electrode 520 to prevent external moisture from entering the organic light emitting diode 500. Although not shown in the drawings, the encapsulation layer 490 may have a trilayer structure in which a first inorganic layer, an organic layer and a second inorganic layer are sequentially stacked, without being limited thereto.

[0097] Next, the present invention will be described in more detail with reference to examples. However, it should be noted that these examples are provided for illustration only and should not be construed in any way as limiting the invention.

EXAMPLES

Example 1

[0098] In a vacuum chamber at a pressure of 5×10^{-8} to 7×10^{-8} torr, an organic light emitting diode was fabricated by sequentially depositing a hole injection layer, a hole transport layer (HTL1), a blue light emitting layer (a blue host material (BH) and a blue fluorescent dopant material (BD, with 4 wt % doping)), an electron transport layer (ETL1), an electron injection layer (LiF) and a cathode on an ITO substrate (anode).

[0099] FIG. 6 is an energy diagram depicting the energy levels of HTL1/BH+BD/ETL1 of the fabricated organic light emitting diode. In evaluation of the energy level, it could be seen that, in the fabricated organic light emitting diode, the difference between the HOMO energy level of HTL1 and the HOMO energy level of BD was 0.1 eV or less. Referring to FIG. 6, the difference between the HOMO energy level of HTL1 and the HOMO energy level of BD is 0.1 eV or less, as indicated by dotted lines.

Comparative Example 1

[0100] In a vacuum chamber at a pressure of 5×10^{-8} to 7×10^{-8} torr, an organic light emitting diode was fabricated by sequentially depositing a hole injection layer, a hole transport layer (HTL2), a blue light emitting layer (a blue host material (BH) and a blue fluorescent dopant material (BD, with 4 wt % doping)), an electron transport layer (ETL1), an electron injection layer (LiF) and a cathode on an ITO substrate (anode).

[0101] FIG. 7 is an energy diagram depicting the energy levels of HTL2/BH+BD/ETL1 of the fabricated organic light emitting diode of Comparative Example 1. In evaluating the energy levels, it could be seen that, in the fabricated organic light emitting diode, the difference between the HOMO energy level of HTL1 and the HOMO energy level of BD was greater than 0.1 eV. Referring to FIG. 7, the difference between the HOMO energy level of HTL1 and the HOMO energy level of BD was greater than 0.1 eV, as indicated by dotted lines.

[0102] The materials used in Example 1 and Comparative Example 1 and energy levels thereof are shown as follows.

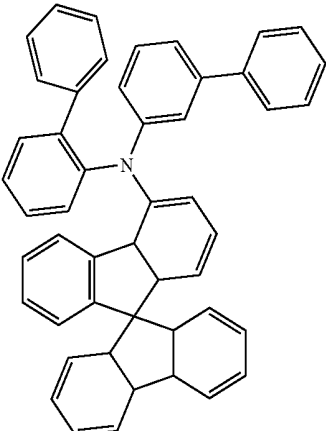
Name	Structure	HOMO (eV)	LUMO (eV)	T ₁ (eV)
HTL1		-5.79	-2.57	2.82

-continued

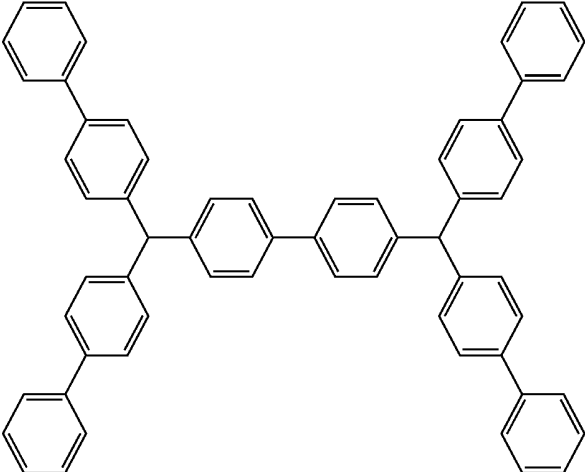
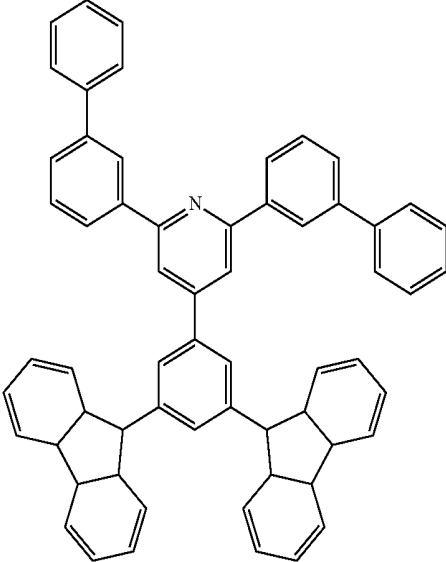
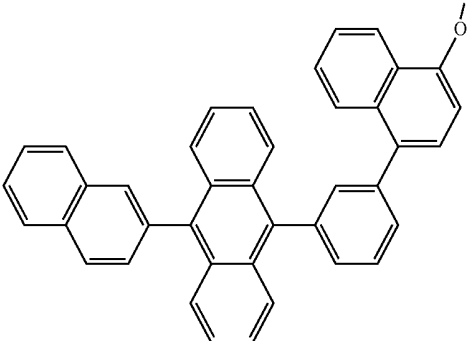
Name	Structure	HOMO (eV)	LUMO (eV)	T ₁ (eV)
HTL 2		-5.50	-2.42	2.52
ETL1		-6.21	-2.73	2.67
BH		-6.00	-2.99	1.85

-continued

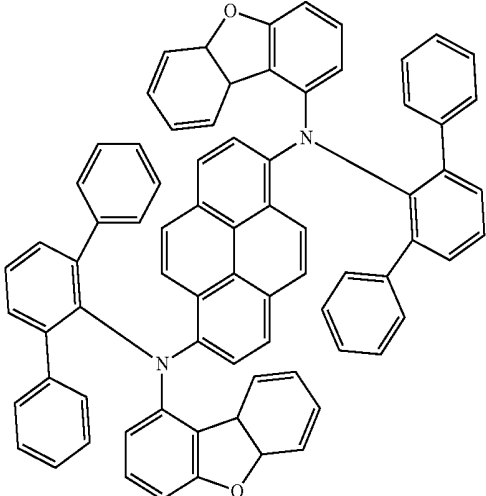
Name	Structure	HOMO (eV)	LUMO (eV)	T ₁ (eV)
BD		-5.61	-2.81	—

Experimental Example 1: Evaluation of Characteristics of Organic Light Emitting Diode

[0103] The operation characteristics of the organic light emitting diodes fabricated in Example 1 and Comparative Example 1 were evaluated.

[0104] Table 1 shows the voltage-current density, brightness-current efficiency, brightness-external quantum efficiency (EQE), and lifespan of the organic light emitting diodes fabricated in Example 1 and Comparative Example 1.

TABLE 1

Item	Voltage (V)	Voltage-current density (Cd/A)	Brightness-external quantum efficiency (EQE)	Lifespan (hr)
Example 1	3.7	8.0	8.1	50
Comparative Example 1	4.8	7.2	7.1	30

[0105] The hole transport layer (HTL2) used in Comparative Example 1 has a shallower energy level than the hole transport layer HTL1 used in Example 1 and thus does not satisfy the following condition (D):

[0106] (D) The hole transport layer material has a higher HOMO energy level than the blue fluorescent dopant material and the difference in the HOMO energy levels between the hole transport layer material and the blue fluorescent dopant material is 0.1 eV or less. By comparison, the difference between the HOMO energy levels is greater than 0.1 eV in Comparative Example 1.

[0107] In Comparative Example 1, the difference in the HOMO energy levels between the hole transport layer (HTL2) and the blue host material (BH) is large, thereby making it difficult for the injection of holes into the light emitting layer. As a result, the driving voltage of the organic light emitting diode increases.

[0108] In addition, the organic light emitting diode of Comparative Example 1 has a shorter lifespan than the organic light emitting diode of Example 1.

[0109] Although the present invention has been described with reference to some embodiments in conjunction with the accompanying drawings, it should be understood that the foregoing embodiments are provided for illustration only and are not to be in any way construed as limiting the present invention, and that various modifications, changes, alterations, and equivalent embodiments can be made by those skilled in the art without departing from the spirit and scope of the invention.

LIST OF REFERENCE NUMERALS

- [0110]** 100, 200, 300, 500: organic light emitting diode
- [0111]** 110, 210, 310, 410, 510: first electrode
- [0112]** 120, 220, 320, 420, 520: second electrode
- [0113]** 140, 240, 530: light emitting stack
- [0114]** 141, 241, 341, 351: hole transport layer
- [0115]** 142, 242, 342, 352: blue light emitting layer
- [0116]** 243: hole injection layer
- [0117]** 244: electron transport layer
- [0118]** 245: electron injection layer
- [0119]** 340: first light emitting stack
- [0120]** 350: second light emitting stack
- [0121]** 360: charge generation layer
- [0122]** 362: N-type charge generation layer
- [0123]** 364: P-type charge generation layer
- [0124]** 400: organic light emitting display

What is claimed is:

1. An organic light emitting diode comprising:
 - a first electrode;
 - a light emitting stack disposed on the first electrode; and
 - a second electrode disposed on the light emitting stack,
 wherein the light emitting stack comprises a hole transport layer and a blue light emitting layer such that the hole transport layer and the blue light emitting layer are sequentially stacked on the first electrode, the blue light emitting layer comprising a blue host material and a blue fluorescent dopant material, and the hole transport layer comprising a hole transport layer material,

wherein:

- the blue fluorescent dopant material has a higher LUMO (Lowest Unoccupied Molecular Orbital) energy level than the blue host material;
 - the blue fluorescent dopant material has a higher HOMO (Highest Occupied Molecular Orbital) energy level than the blue host material;
 - the hole transport layer material has a higher HOMO energy level than the blue host material;
 - the hole transport layer material has a higher HOMO energy level than the blue fluorescent dopant material and a difference in the HOMO energy levels between the hole transport layer material and the blue fluorescent dopant material is 0.1 eV or less; and
 - the blue fluorescent dopant material has a lower singlet energy level than the blue host material.
2. The organic light emitting diode according to claim 1, wherein the blue host material comprises an anthracene-containing compound.
3. The organic light emitting diode according to claim 1, wherein the blue fluorescent dopant material comprises a pyrene amine-containing compound.
4. The organic light emitting diode according to claim 1, wherein the blue light emitting layer comprises 1 wt % to 5 wt % of the blue fluorescent dopant material.
5. The organic light emitting diode according to claim 1, wherein the light emitting stack consists of a first light emitting stack and at least one additional light emitting stack comprising a second light emitting stack is further interposed between the first electrode and the second electrode.
6. The organic light emitting diode according to claim 5, further comprising:
a charge generation layer interposed between the first light emitting stack and the second light emitting stack.

7. The organic light emitting diode according to claim 6, wherein the charge generation layer comprises an N-type charge generation layer and a P-type charge generation layer.

8. The organic light emitting diode according to claim 5, wherein the organic light emitting diode is a white organic light emitting diode and the additional light emitting stack emits red (R), green (G) or yellow (Y) light.

9. An organic light emitting display comprising:

- a substrate;
- the organic light emitting diode according to claim 1 disposed on the substrate; and
- a driving device interposed between the substrate and the organic light emitting diode and connected to the first electrode.

10. The organic light emitting display according to claim 9, further comprising:

- a color filter interposed between the substrate and the first electrode or disposed on the organic light emitting diode.

11. The organic light emitting display according to claim 9, wherein the blue host material of the organic light emitting diode comprises an anthracene-containing compound.

12. The organic light emitting display according to claim 9, wherein the blue fluorescent dopant material of the organic light emitting diode comprises a pyrene amine-containing compound.

13. The organic light emitting display according to claim 9, wherein the blue light emitting layer of the organic light emitting diode comprises 1 wt % to 5 wt % of the blue fluorescent dopant material.

* * * * *

专利名称(译)	有机发光二极管和包括其的有机发光显示器		
公开(公告)号	US20190198791A1	公开(公告)日	2019-06-27
申请号	US16/217164	申请日	2018-12-12
[标]申请(专利权)人(译)	乐金显示有限公司		
申请(专利权)人(译)	LG DISPLAY CO. , LTD.		
当前申请(专利权)人(译)	LG DISPLAY CO. , LTD.		
[标]发明人	KIM SANGBEOM SEO JEONGDAE KIM DOHAN KANG HYESEUNG YOO SEONKEUN YOON SEUNGHEE		
发明人	KIM, SANGBEOM SEO, JEONGDAE KIM, DOHAN KANG, HYESEUNG YOO, SEONKEUN YOON, SEUNGHEE RYU, DAEWON SHIN, JICHEOL		
IPC分类号	H01L51/50 H01L51/52 H01L27/32		
CPC分类号	H01L51/506 H01L51/5004 H01L51/5203 H01L51/5262 H01L27/3209		
优先权	1020170178313 2017-12-22 KR		
外部链接	Espacenet USPTO		

摘要(译)

公开了一种有机发光二极管和包括该有机发光二极管的有机发光显示器，其中所述有机发光二极管包括：第一电极；发光堆叠设置在第一电极上；第二电极设置在发光叠层上，其中发光叠层包括空穴传输层和蓝色发光层，使得空穴传输层和蓝色发光层依次堆叠在第一电极上，其中蓝色发光层包括蓝色主体材料和蓝色荧光掺杂剂材料，并且空穴传输层包括空穴传输层材料。蓝色荧光掺杂剂材料具有比蓝色主体材料更高的LUMO能级，并且蓝色荧光掺杂剂材料具有比蓝色主体材料更高的HOMO能级。

